

2

LINEADUE

NUOVA

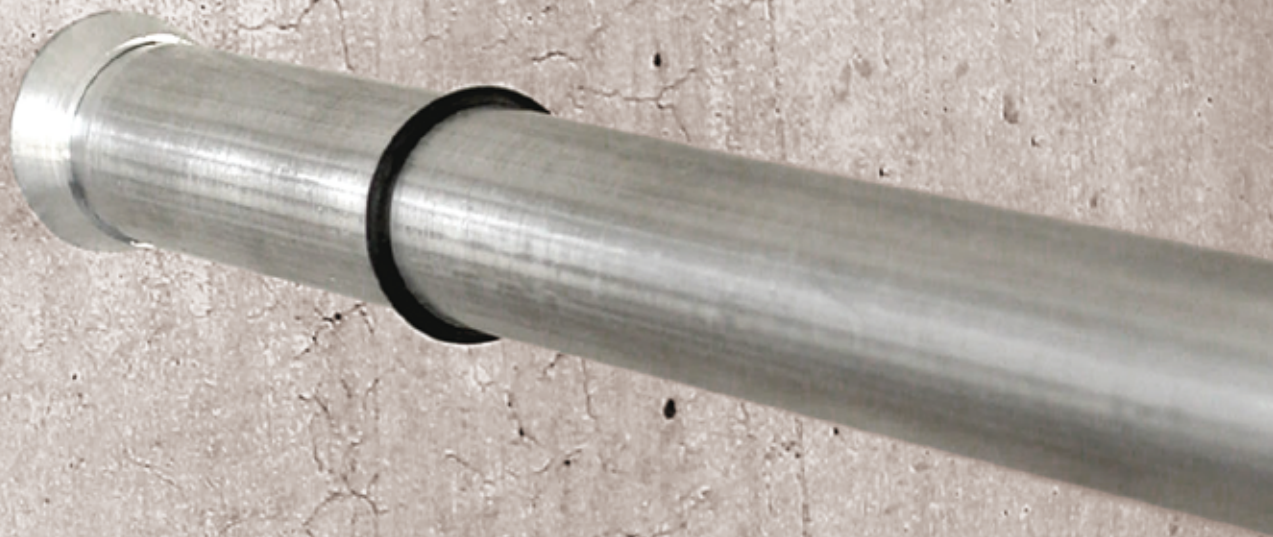

BRUGNOTTO[®]
SHOP INTERIORS

BRUGNOTTO® SHOP INTERIORS



BRUGNOTTO SHOP INTERIORS produce sistemi di arredi modulari per negozi e spazi espositivi.

L'azienda è stata fondata nel 1980 e ha sede nel nord est d'Italia, a 40 km dalla città di Venezia.

Nei suoi stabilimenti di 18.000 mq, sono presenti le più moderne tecnologie produttive ed operano abili professionisti e designers con grande esperienza nel fashion retail design.

BRUGNOTTO SHOP INTERIORS offre soluzioni di arredo innovativo per nuovi spazi commerciali, grazie anche alla capacità di abbinare più materiali, quali vere pelli selezionate, ecopelle stampata e verniciata, metalli e legni con particolari finiture.

Tutti questi materiali vengono lavorati all'interno dell'azienda con cura e sapienza artigianale rendendo BRUGNOTTO SHOP INTERIORS una realtà unica ed esclusiva.



BRUGNOTTO SHOP INTERIORS produces modular pieces of furniture for shops and show spaces.

The company was founded in 1980 with its headquarters in northeastern Italy, 40 kilometres from Venice.

Its headquarters is comprised of 18.000 square metres where the most up-to-date production technology is used by designers and professionals who have a vast experience in modern retail design.

BRUGNOTTO SHOP INTERIORS is able to find innovative furnishing solutions for new commercial spaces thanks to the ability of using different materials, such as carefully chosen genuine leather, printed and varnished eco-leather, various different metals and types of wood with particular finishings.

All these specified materials are used within the company using great care and specialist knowledge making BRUGNOTTO SHOP INTERIORS completely unique and exclusive.



2

LINEADUE

NUOVA



LINEA DUE

Pannelli di varie misure con finitura cemento, lamiera ossidata ed abete nodato, offrono la possibilità di rivestire intere pareti e di attrezzarle.

Linea minimale ma nel contempo versatile, geniale e multifunzionale.

Spazi come show rooms, corner shops, negozi possono trovare in questa linea diverse soluzioni di arredo innovativo.

LINE TWO

Panels of various sizes with concrete, oxidized sheet and knotted fir finishing, can be used to line and equip entire walls.

Not only with a minimal, but also versatile, clever and multi-functional line, this collection offers various furnishing solutions for show rooms, corner shops and stores.











ACCESSORI
ACCESSORIES

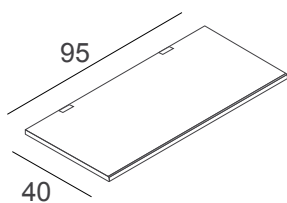

2ME/N
Mensola in nobilitato
Shelf in faced panel
L95 x P40 cm

2ME/L
Mensola in nobilitato lucido
Shelf in glossy faced panel
L95 x P40 cm

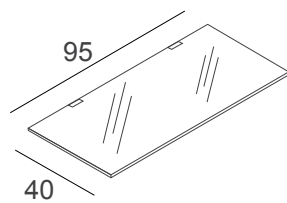
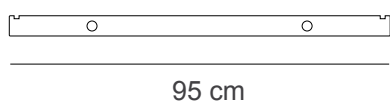

2ME/V
Mensola in vetro temperato
Shelf in tempered glass
L95 x P40 cm

2BAP
Barra appenderia in metallo
Metal crossbar
L95 x H3,5 cm

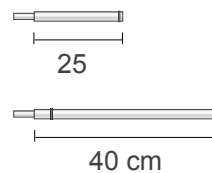

2PP
Perno app. frontale alluminio
Frontal hanging pin aluminium
L25 cm Ø 2 cm

2PG
Coppia perni alluminio per mensole o barra appenderia
Pair of supporting pins aluminium for shelf or crossbar
L40 cm Ø 2 cm



MODULI - TAVOLI
MODULES - TABLES

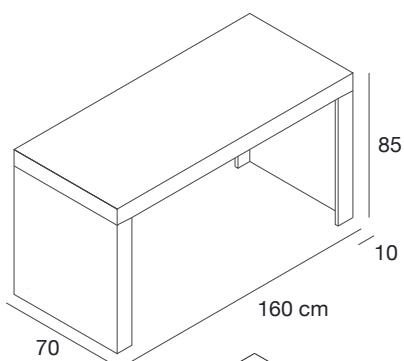

2T01/N
tavolo
nobilitato
table
faced panel
L160 x P70 x H85 cm

2T01/L
Tavolo
nobilitato lucido
Table
glossy faced panel
L160 x P70 x H85 cm

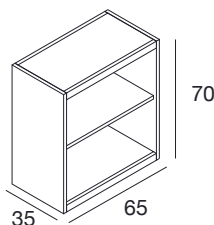

2T02/N
modulo vani con ruote
nobilitato
compartment with wheels
faced panel
L35 x P65 x H70 cm

2T02/L
modulo vani con ruote
nobilitato lucido
compartment with wheels
glossy faced panel
L35 x P65 x H70cm

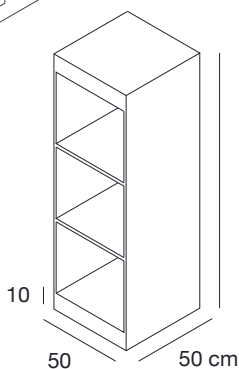
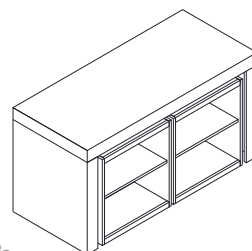

2M01/N
Modulo vani
nobilitato
Compartment module
faced panel
L50 x P50 x H150 cm

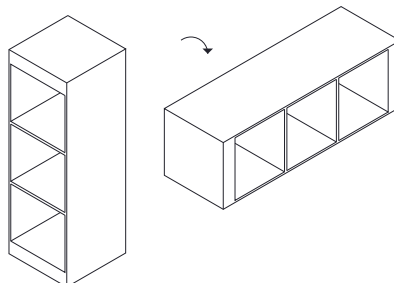

2M01/L
Modulo vani
nobilitato lucido
Compartment module
glossy faced panel
L50 x P50 x H150 cm



**SEDUTE
SEATS**

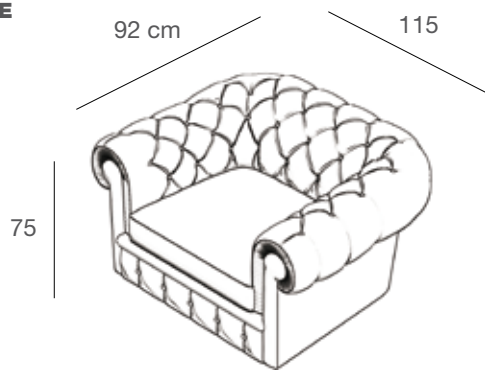

2CHES/S
Poltrona
Armchair
L.115 x P. 92 x H.75 cm

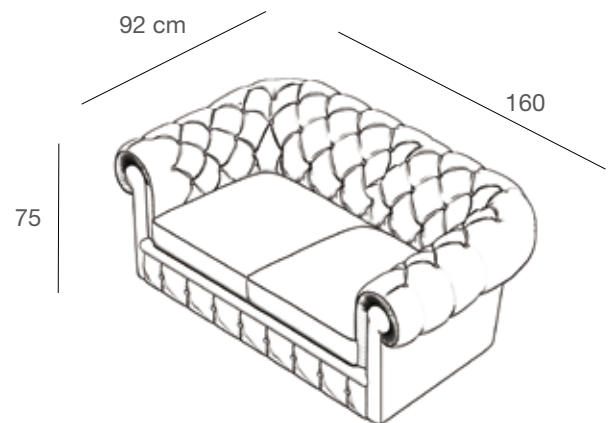

2CHES/L
Divano a due posti
Two seat sofa
L.160 x P. 92 x H.75 cm



ELEMENTI SELF STANDING
SELF STANDING ELEMENTS

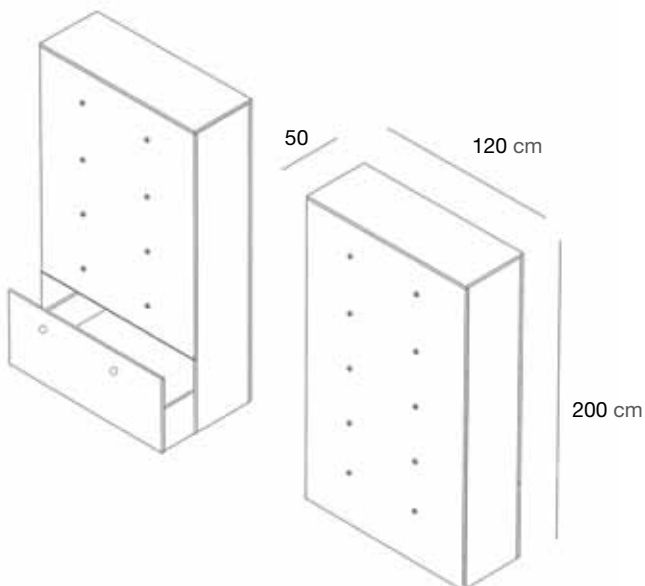

2PAR/N

Modulo self standing attrezzabile con cassetto in nobilitato

Self standing element suitale with drawer in faced panel

L.120 x P.50 x H.200 cm

2PAR/L

Modulo self standing attrezzabile con cassetto in nobilitato lucido

Self standing element suitale with drawer in glossy faced panel

L.120 x P.50 x H.200 cm

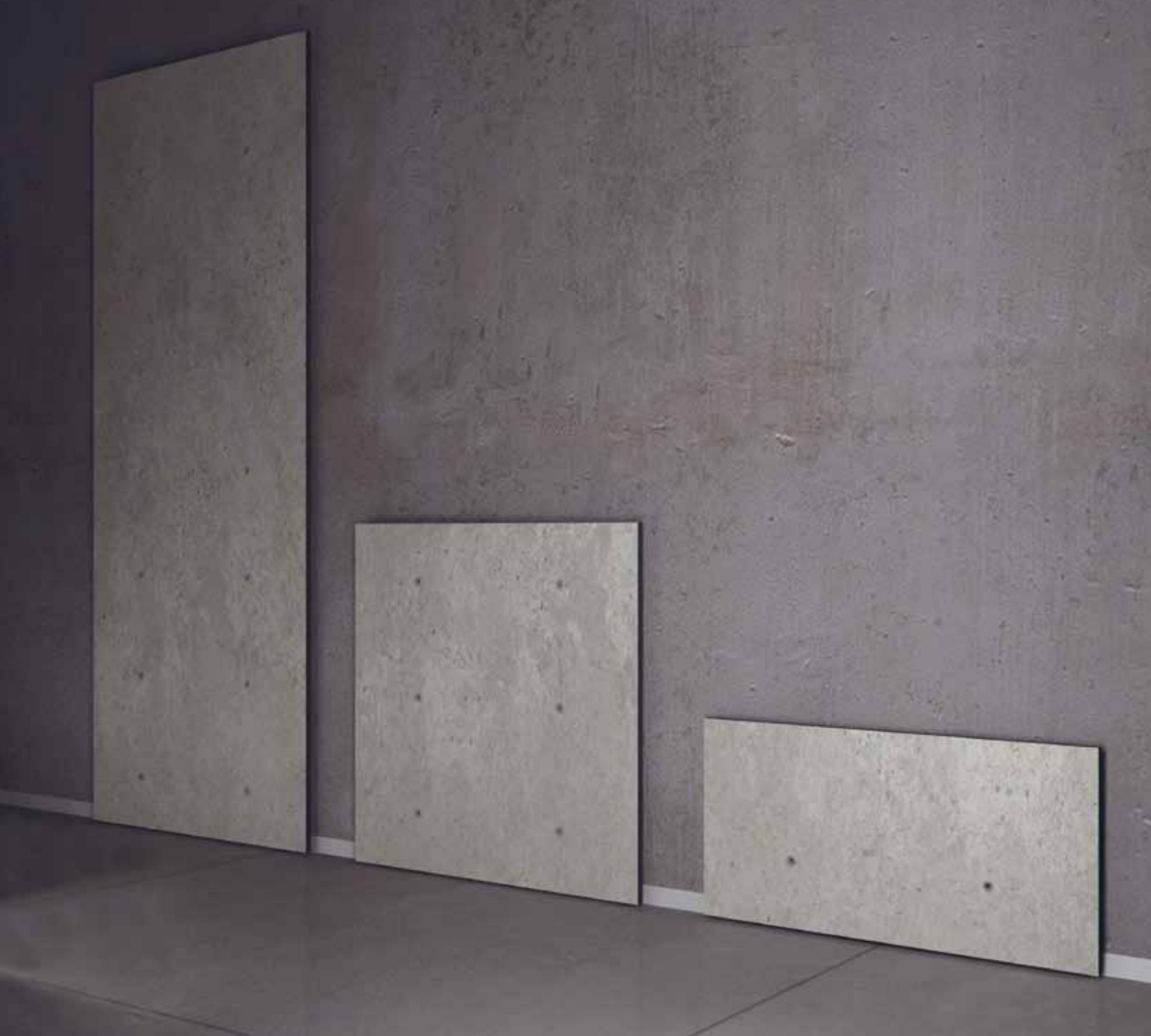

PANNELLI ATTREZZABILI
EQUIPABLE PANELS

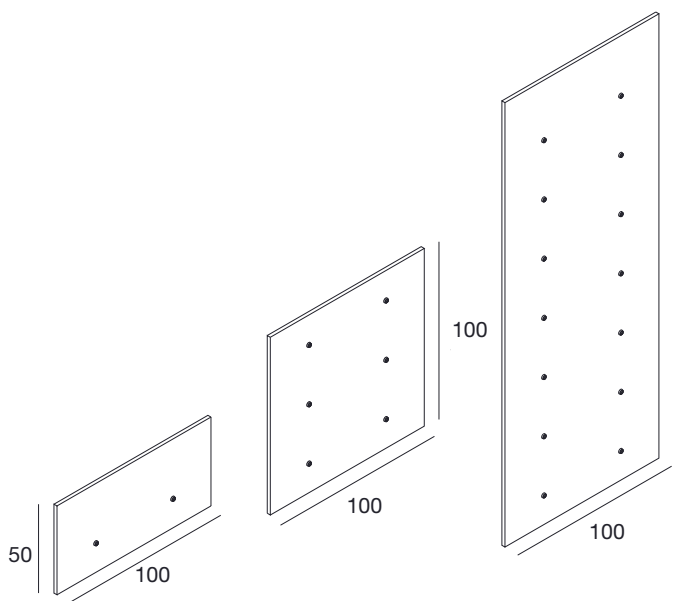

	<p>2PA1/N nobilitato <i>faced panel</i> L.100 x H.50 cm</p>	<p>2PA1/L nobilitato lucido <i>glossy faced panel</i> L.100 x H.50 cm</p>
250	<p>2PA2/N nobilitato <i>faced panel</i> L.100 x H.10 cm</p>	<p>2PA2/L nobilitato lucido <i>glossy faced panel</i> L.100 x H.10 cm</p>
	<p>2PA3/N nobilitato <i>faced panel</i> L.100 x H.250 cm</p>	<p>2PA3/L nobilitato lucido <i>glossy faced panel</i> L.100 x H.250 cm</p>



CAMERINI
CHANGING ROOMS

2CAM
Struttura curva in metallo
per camerino
*Curved metal structure
for changing room*
L.100 x P.100 cm

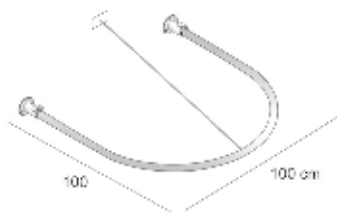

2GA
Gancio appenderia in
metallo
Metal clothes hanger
L.10 cm

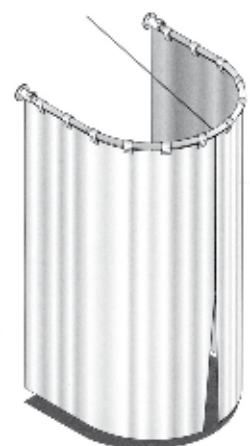
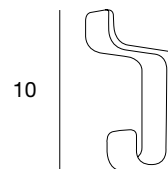

2TEV
Tenda
Curtain
L.140 x H.200 cm



2MRR/N
Cornice in nobilitato
Frame in faced panel
L.85 x H.205 cm

2MRR/L
Cornice in nobilitato lucido
Frame in glossy faced panel
L.85 x H.205 cm



2 LED

LINEADUE



ELEMENTI SELF STANDING
SELF STANDING ELEMENTS

2PAR/NE

Modulo self standing attrezzabile,
 elettrificato e con cassetto in nobilitato
*Self standing element suitale,
 electrified and with drawer in faced panel*
 L.120 x P.50 x H.200 cm

2PAR/LE

Modulo self standing attrezzabile,
 elettrificato e con cassetto in nobilitato lucido
*Self standing element suitale,
 electrified and with drawer in glossy faced panel*
 L.120 x P.50 x H.200 cm

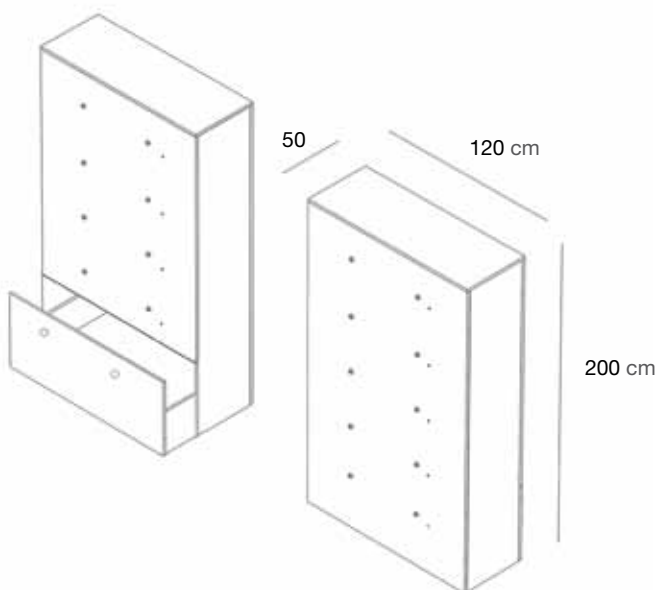



PANNELLI ATTREZZABILI LED
LED EQUIPABLE PANELS

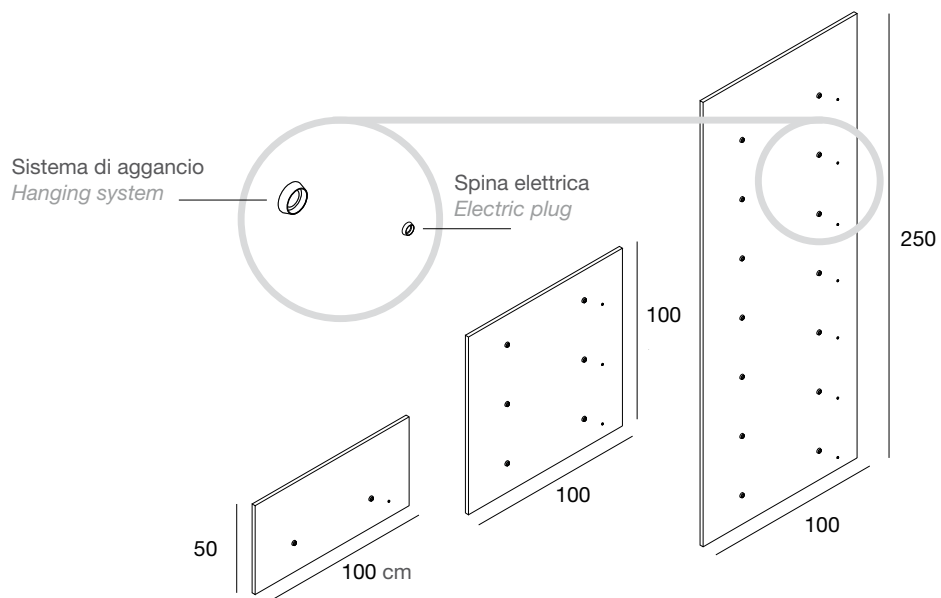



2PA1/NLED

Pannello in nobilitato con spina per mensola LED
Faced panel with plug for LED shelves
 L.100x H.50 cm

2PA1/LLED

Pannello in nobilitato lucido con spina per mensola LED
Glossy faced panel with plug for LED shelves
 L.100x H.50 cm

2PA2/NLED

Pannello in nobilitato con spina per mensola LED
Faced panel with plug for LED shelves
 L.100x H.100 cm

2PA2/LLED

Pannello in nobilitato lucido con spina per mensola LED
Glossy faced panel with plug for LED shelves
 L.100x H.100 cm

2PA3/NLED

Pannello in nobilitato con spina per mensola LED
Faced panel with plug for LED shelves
 L.100x H.250 cm

2PA3/LLED

Pannello in nobilitato lucido con spina per mensola LED
Glossy faced panel with plug for LED shelves
 L.100x H.250 cm

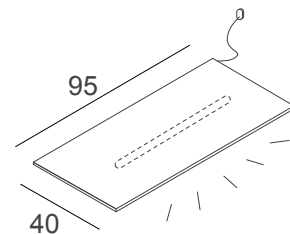

2ME/NLED

Mensola in nobilitato con LED a scomparsa
Shelf in faced panel with hidden LED
 L.95 x P.40 cm

2ME/LLED

Mensola in nobilitato lucido con LED a scomparsa
Shelf in glossy faced panel with hidden LED
 L.95 x P.40 cm

NOBILITATI
FACED PANELS



BIANCO LUCIDO
GLOSSY WHITE



NERO LUCIDO
GLOSSY BLACK

NOBILITATI
FACED PANELS



ABETE NODATO
KNOTTED FIR



ABETE VISSUTO BIANCO
WHITE VINTAGE FIR



CEMENTO
CONCRETE

ACCESSORI
ACCESSORIES



ALLUMINIO
ALUMINIUM



ROVERE TAVOLATO
PLANKED OAK



ABETE GESSATO
CHALKY FIR



LAMIERA OSSIDATA
OXIDIZED SHEET



VETRO TEMPERATO
CLEAR GLASS

FINITURE TESSUTI
FABRIC FINISHES



VELLUTO BEIGE
VELVET BEIGE



VELLUTO ROSSO
VELVET RED



VELLUTO NERO
VELVET BLACK



TAFTA' CRINKLE NEWCREAM
TAFTA' CRINKLE NEWCREAM











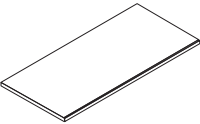
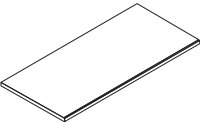

TAFTA' CRINKLE GRIGIO
TAFTA' CRINKLE GREY

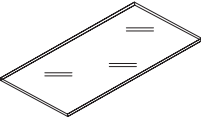
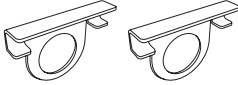

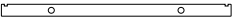

TAFTA' CRINKLE BORDEAUX
TAFTA' CRINKLE BORDEAUX

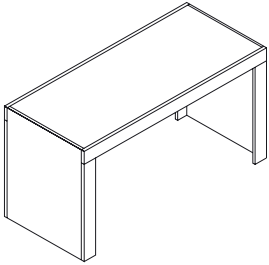
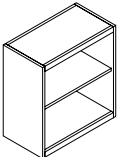
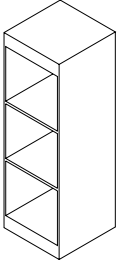

TAFTA' CRINKLE GREEN
TAFTA' CRINKLE GREEN

CODICE CODE	DESCRIZIONE DESCRIPTION	PREZZO PRICE	PAG. PAGE	
ACCESSORI ACCESSORIES				
2ME/N	Mensola in nobilitato opaco L.95xP.40cm sp.18mm <i>Shelf in matt chipboard L.95xP.40cm sp.18mm</i>	€ 37,00	6	
2ME/L	Mensola in nobilitato verniciato lucido (BIANCO/NERO), L.95xP.40cm sp.18mm <i>Shelf in glossy chipboard (WHITE/BLACK), L.95xP.40cm sp.18mm</i>	€ 53,00	6	
 JIT				
2ARL	Coppia ganci antiribaltamento per mensola legno in alluminio <i>Pair of aluminium locking hooks for wooden shelves</i>	€ 3,50	6	
2ME/V	Mensola L.95xP.40cm sp.8mm in vetro temperato <i>Shelf L.95xP.40cm sp.8mm in tempered glass</i>	€ 42,00	6	
2ARV	Coppia ganci antiribaltamento per mensola vetro in alluminio <i>Pair of aluminium locking hooks for glass shelves</i>	€ 3,50	6	
 JIT				
2BAP	Barra appenderia lunghezza 95cm in alluminio <i>Crossbar L.95cm in aluminium</i>	€ 43,50	6	
 JIT				
2PP	N.1 Perno appenderia frontale lunghezza 25cm in alluminio <i>N.1 Frontal hanging pin L.25cm in aluminium</i>	€ 19,00	6	
 JIT				
2PG	Coppia perni per mensole o barra appenderia lunghezza 40cm in alluminio <i>Pair of supporting pins for shelf and crossbar L.40cm in aluminium</i>	€ 41,50	6	
 JIT				

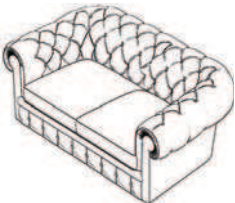
CODICE <i>CODE</i>	DESCRIZIONE <i>DESCRIPTION</i>	PREZZO <i>PRICE</i>	PAG. <i>PAGE</i>	
MODULI E TAVOLI <i>UNITS AND TABLES</i>				
2T01/N	Tavolo in nobilitato opaco. L.160xP.70 H.85cm <i>Display table in matt chipboard. L.160xP.70 H.85cm</i>	€ 395,00	7	 
2T01/L	Tavolo in nobilitato verniciato lucido (BIANCO/NERO). L.160xP.70 H.85cm <i>Display table in glossy chipboard (WHITE/BLACK). L.160xP.70 H.85cm</i>	€ 495,00	7	
2T02/N	Modulo a 2 vani con ruote in nobilitato opaco. L.65xP.35cm H.70cm <i>2 compartments unit with wheels in matt chipboard. L.65xP.35cm H.70cm</i>	€ 190,00	7	
2T02/L	Modulo a 2 vani con ruote in nobilitato verniciato lucido (BIANCO/NERO). L.65xP.35cm H.70cm <i>2 compartments unit with wheels in glossy chipboard (WHITE/BLACK). L.65xP.35cm H.70cm</i>	€ 210,00	7	
2M01/N	Modulo a 3 vani in nobilitato opaco. L.50xP.50cm H.150cm <i>3 compartments unit in matt chipboard. L.50xP.50cm H.150cm</i>	€ 290,00	7	
2M01/L	Modulo a 3 vani in nobilitato verniciato lucido (BIANCO/NERO). L.50xP.50cm H.150cm <i>3 compartments unit in glossy chipboard (WHITE/BLACK). L.50xP.50cm H.150cm</i>	€ 360,00	7	
SEDUTE <i>SEATS</i>				
2CHES/S	Poltrona singola imbottita e rivestita in Ecopelle testa di moro vintage. L.115xP.92xH.75cm <i>Single armchair padded and covered with synthetic leather brown vintage. L.115xP.92xH.75cm</i>	€ 1.425,00	8	
2CHES/L	Divano a due posti imbottito e rivestito in Eco-pelle testa di moro vintage. L.160xP.92xH.75cm <i>Double armchair padded and covered with synthetic leather brown vintage. L.160xP.92xH.75cm</i>	€ 1.670,00	8	

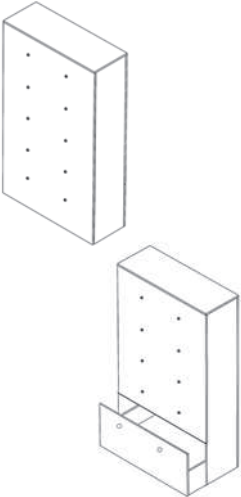
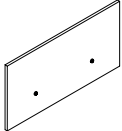
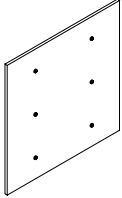
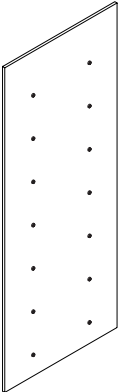
CODICE <i>CODE</i>	DESCRIZIONE <i>DESCRIPTION</i>	PREZZO <i>PRICE</i>	PAG. <i>PAGE</i>	
ELEMENTI SELF STANDING <i>SELF STANDING ELEMENT</i>				
2PAR/N	Modulo self standing attrezzabile con cassetto in nobilitato opaco. L.120xP.50xH.200cm <i>Self standing element with drawer in matt chipboard. L.120xP.50xH.200cm</i>	€ 900,00	9	
2PAR/L	Modulo self standing attrezzabile con cassetto in nobilitato verniciato lucido (BIANCO/NERO). L.120xP.50xH.200cm <i>Self standing element with drawer in glossy chipboard (WHITE/BLACK). L.120xP.50xH.200cm</i>	€ 1.070,00	9	
PANNELLI ATTREZZABILI CON BOCCOLE <i>EQUIPPABLE FERRULED PANELS</i>				
2PA1/N	Pannello boccolato in nobilitato opaco. L.100xP.50cm <i>Ferruled panel in matt chipboard. L.100xP.50cm</i>	€ 100,00	10	
2PA1/L	Pannello boccolato in nobilitato verniciato lucido (BIANCO/NERO). L.100xP.50cm <i>Ferruled panel in glossy chipboard (WHITE/BLACK). L.100xP.50cm</i>	€ 103,00	10	
2PA2/N	Pannello boccolato in nobilitato opaco. L.100xP.100cm <i>Ferruled panel in matt chipboard. L.100xP.100cm</i>	€ 180,00	10	
2PA2/L	Pannello boccolato in nobilitato verniciato lucido (BIANCO/NERO). L.100xP.100cm <i>Ferruled panel in glossy chipboard (WHITE/BLACK). L.100xP.100cm</i>	€ 195,00	10	
2PA3/N	Pannello boccolato in nobilitato opaco. L.250xP.100cm <i>Ferruled panel in matt chipboard. L.250xP.100cm</i>	€ 340,00	10	
2PA3/L	Pannello boccolato in nobilitato verniciato lucido (BIANCO/NERO). L.250xP.100cm <i>Ferruled panel in glossy chipboard (WHITE/BLACK). L.250xP.100cm</i>	€ 385,00	10	

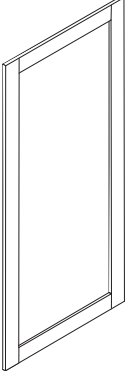
CODICE <i>CODE</i>	DESCRIZIONE <i>DESCRIPTION</i>	PREZZO <i>PRICE</i>	PAG. <i>PAGE</i>	
CAMERINO <i>CHANGING ROOM</i>				
2CAM	Struttura curva per camerino in metallo L.100xP.100cm <i>Curved metal structure for changing room L.100xP.100cm</i>	€ 225,00	11	
2TEV	Tenda doppia in tessuto per camerino curvo. <i>Double fabric curtain for changing room.</i>	€ 390,00	11	
2MRR/N	Specchio, cornice in nobilitato opaco. L.85xH.205cm <i>Mirror, frame in matt chipboard. L.85xH.205cm</i>	€ 310,00	11	
2MRR/L	Specchio, cornice in nobilitato verniciato lucido (BIANCO/NERO). L.85xH.205cm <i>Mirror, glossy chipboard frame (WHITE/BLACK). L.85xH.205cm</i>	€ 365,00	11	
2MRR/EP	Specchio, cornice rivestita in ecopelle opaca. L.85xH.205cm <i>Mirror, frame covered with synthetic matt leather. L.85xH.205cm</i>	€ 451,00	11	
2MRR/EPL	Specchio, cornice rivestita in ecopelle lucida. L.85xH.205cm <i>Mirror, frame covered with synthetic glossy leather. L.85xH.205cm</i>	€ 466,00	11	
2GA	n.1 Gancio appenderia in metallo <i>n.1 Hanger in metal</i>	€ 32,00	11	
ELEMENTI SELF STANDING ELETTRIFICATI <i>ELECTRIFIED SELF STANDING ELEMENTS</i>		2 LED LINEADUE		
2PAR/NE	Modulo self standing attrezzabile, elettrificato (con N.2 alimentatori a 5 vie) con cassetto in nobilitato opaco. L.120xP.50xH.200cm <i>Self standing element with drawer in matt chipboard. Electrified (with N.2 power suppliers). L.120xP.50xH.200cm</i>			€ 1.275,00
2PAR/LE	Modulo self standing attrezzabile, elettrificato (con N.2 alimentatori a 5 vie) con cassetto in nobilitato verniciato lucido (BIANCO/NERO). L.120xP.50xH.200cm <i>Self standing element with drawer in glossy chipboard (WHITE/BLACK). Electrified (with N.2 power suppliers). L.120xP.50xH.200cm</i>	€ 1.455,00	13	

CODICE <i>CODE</i>	DESCRIZIONE <i>DESCRIPTION</i>	PREZZO <i>PRICE</i>	PAG. <i>PAGE</i>
PANNELLI ATTREZZABILI CON BOCCOLE ELETRIFICATI <i>ELECTRIFIED EQUIPPABLE FERRULED PANELS</i>			
2PA1/NLED	Pannello boccolato in nobilitato opaco, con predisposizione per inserimento mensola luminosa. Completo con alimentatore. L.100xP.50cm Ferruled panel in matt chipboard with electrification settings for LED shelves. Complete with power supply. L.100xP.50cm	€ 183,00	15
2PA1/LLED	Pannello boccolato in nobilitato verniciato lucido (BIANCO/NERO), con predisposizione per inserimento mensola luminosa. Completo con alimentatore. L.100xP.50cm Ferruled panel in glossy chipboard (WHITE/BLACK) with electrification settings for LED shelves. Complete with power supply. L.100xP.50cm	€ 197,00	15
2PA2/NLED	Pannello boccolato in nobilitato opaco, con predisposizione per inserimento mensola luminosa. Completo con alimentatore. L.100xP.100cm Ferruled panel in matt chipboard with electrification settings for LED shelves. Complete with power supply. L.100xP.100cm	€ 287,00	15
2PA2/LLED	Pannello boccolato in nobilitato verniciato lucido (BIANCO/NERO), con predisposizione per inserimento mensola luminosa. Completo con alimentatore. L.100xP.100cm Ferruled panel in glossy chipboard (WHITE/BLACK) with electrification settings for LED shelves. Complete with power supply. L.100xP.100cm	€ 314,00	15
2PA3/NLED	Pannello boccolato in nobilitato opaco, con predisposizione per inserimento mensola luminosa. Completo con N.2 alimentatori. L.250xP.100cm Ferruled panel in matt chipboard with electrification settings for LED shelves. Complete with N.2 power supplies. L.250xP.100cm	€ 663,00	15
2PA3/LLED	Pannello boccolato in nobilitato verniciato lucido (BIANCO/NERO), con predisposizione per inserimento mensola luminosa. Completo con N.2 alimentatori. L.250xP.100cm Ferruled panel in glossy chipboard (WHITE/BLACK) with electrification settings for LED shelves. Complete with N.2 power supplies. L.250xP.100cm	€ 728,00	15
MENSOLE CON LED <i>LED SHELVES</i>			
2ME/NLED	Mensola in nobilitato opaco, con LED a scomparsa e spinotto di connessione. L.95xP.40cm sp.18mm Shelf in matt chipboard, with strip LED and plug. L.95xP.40cm sp.18mm	€ 128,00	15
2ME/LLED	Mensola in nobilitato verniciato lucido (BIANCO/NERO), con LED a scomparsa e spinotto di connessione. L.95xP.40cm sp.18mm Shelf in glossy chipboard (WHITE/BLACK), with strip LED and plug. L.95xP.40cm sp.18mm	€ 149,00	15
DETTAGLIO <i>DETAIL</i>			

Sistema di aggancio
Hanging system

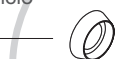

Spina elettrica
Electric plug

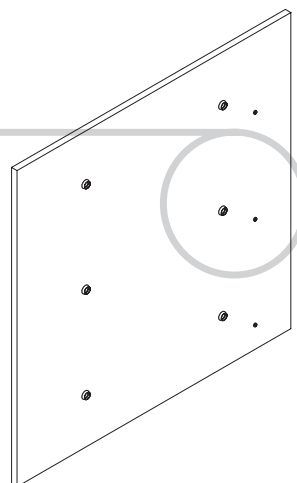

MADE IN ITALY



CONDIZIONI GENERALI DI VENDITA

- La merce viene controllata prima della spedizione. Il vettore è il solo responsabile di eventuali danni. Spetta al cliente controllare la merce all'atto del ritiro e contestare subito al vettore le eventuali avarie e mancanze. Reclami non relativi al trasporto devono essere presentati entro 8 giorni dalla data di ricevimento della merce. Dopo tale termine la merce si intende integralmente accettata.
- La Brugnotto shop interiors si riserva di apportare variazioni tecniche, dimensionali, estetiche a materiali e prodotti.
- Non verranno accettati resi di merce se non preventivamente autorizzati per iscritto da Brugnotto shop interiors. Il reso sarà sempre spedito alla nostra sede franco ogni spesa e adeguatamente imballato nella scatola originale. Imballaggi inadeguati che comportino danni all'articolo, autorizzeranno Brugnotto shop interiors ad addebitare il costo.
- Per qualsiasi controversia il Foro competente sarà quello di Treviso.

GENERAL TERMS OF SALE

- *The goods are checked before any shipment. The carrier is the one responsible for any damage. It's up to the customer to check the goods upon collection and contest immediately the carrier for any lacking or damage.*
- *Brugnotto shop interiors reserves the right to bring any technical, size and aesthetical modifications to the products.*
- *Returned good will not be accepted unless previously authorized by Brugnotto shop interiors in writing by written letter. Returned goods must always be sent to our main offices free of all charges and properly packaged in their original box. Improper boxing, resulting in damage to the item, will authorize Brugnotto shop interiors to charge its cost. The purchaser, under no circumstances, will have a claim on any type of compensation. Penalties may be taken into consideration only upon previous written agreements.*
- *Any dispute will be resolved at the place of jurisdiction of Treviso (Italy).*

BRUGNOTTO®
SHOP INTERIORS

Brugnotto s.r.l.
Via delle Industrie 10
31050 ZENSON DI PIAVE (TV)
Tel. +39 0421 344575 - Fax +39 0421 344226

www.shopinteriors.it
info@shopinteriors.it

